

VT6ER * - 066 - 1 R 00 - A 1 0 - A 1 *

Series

Y - Metric port connection, Omit for UNC

Cam ring for

Volumetric displacement cm³/rev (in³/rev)

042 = 132.3 (8.07)	062 = 196.7 (12.00)
045 = 142.4 (8.69)	066 = 213.3 (13.02)
050 = 158.5 (9.67)	072 = 227.1 (13.86)
052 = 164.8 (10.06)	085 = 269.8 (16.46)
057 = 180.7 (11.02)	

Type of Shaft

- 1 - Keyed (SAE CC)
- 3 - Splined (SAE C)
- 4 - Splined (SAE CC)

Direction of rotation (view on shaft end)

- R - Clockwise
- L - Counter - clockwise

Porting combination

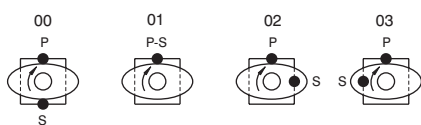

Modifications

Seal class

- 1 = S1 (for mineral oil)
- 4 = S4 (for fire resistant fluids)
- 5 = S5 (for mineral oil and fire resistant fluids)

Design letter

Porting adapter

Coupling

- 1 = SAE A
- 2 = SAE B
- 3 = SAE BB
- 4 = SAE C
- 5 = SAE J498b
- 16/32-11 teeth

Adapter

- 0 = None
- A = SAE A
- B = SAE B
- C = SAE C

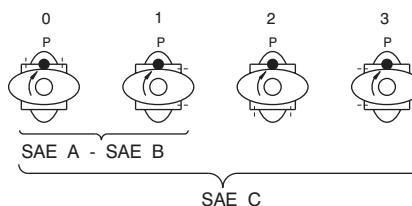

INTERNAL LEAKAGE (TYPICAL)

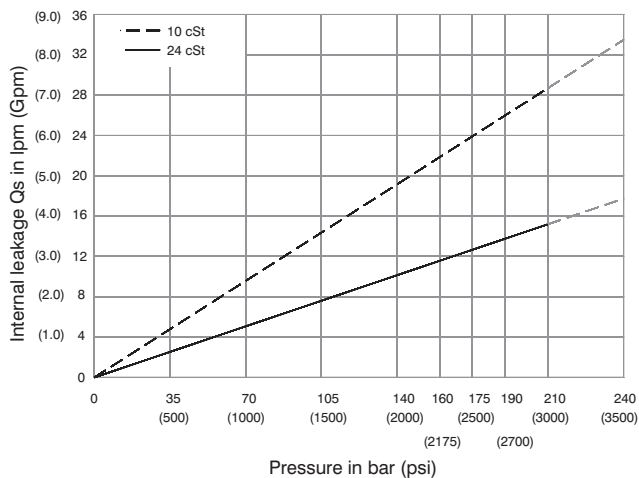

NOISE LEVEL (TYPICAL)

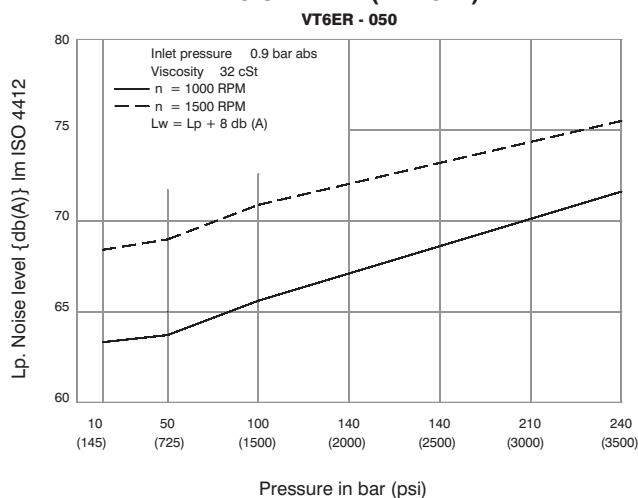

HYDROMECHANICAL POWER LOSS (TYPICAL)

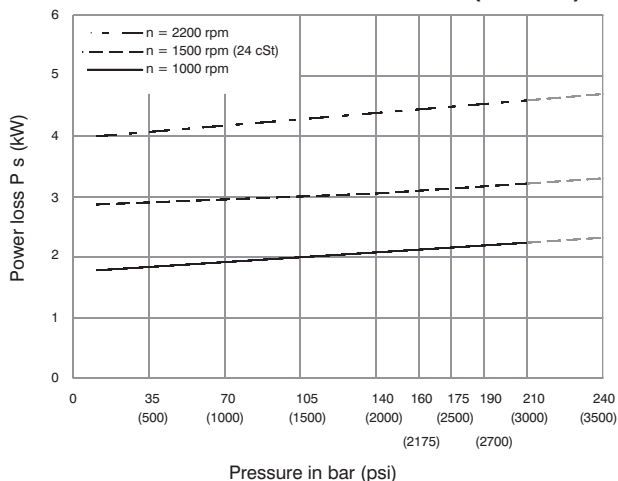

PERMISSIBLE RADIAL LOAD

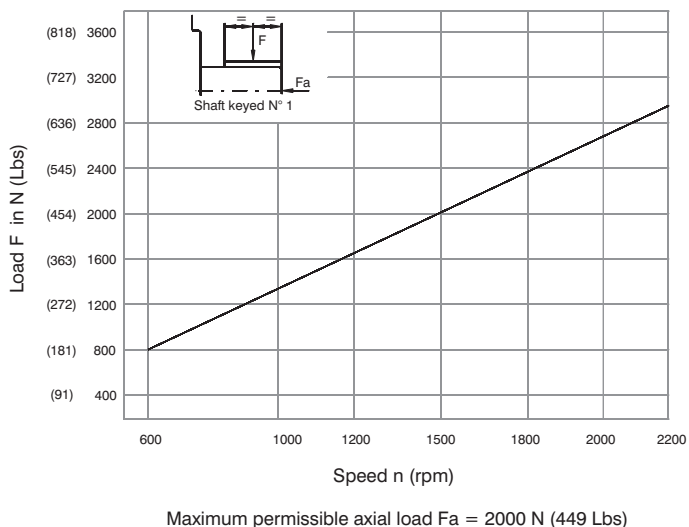

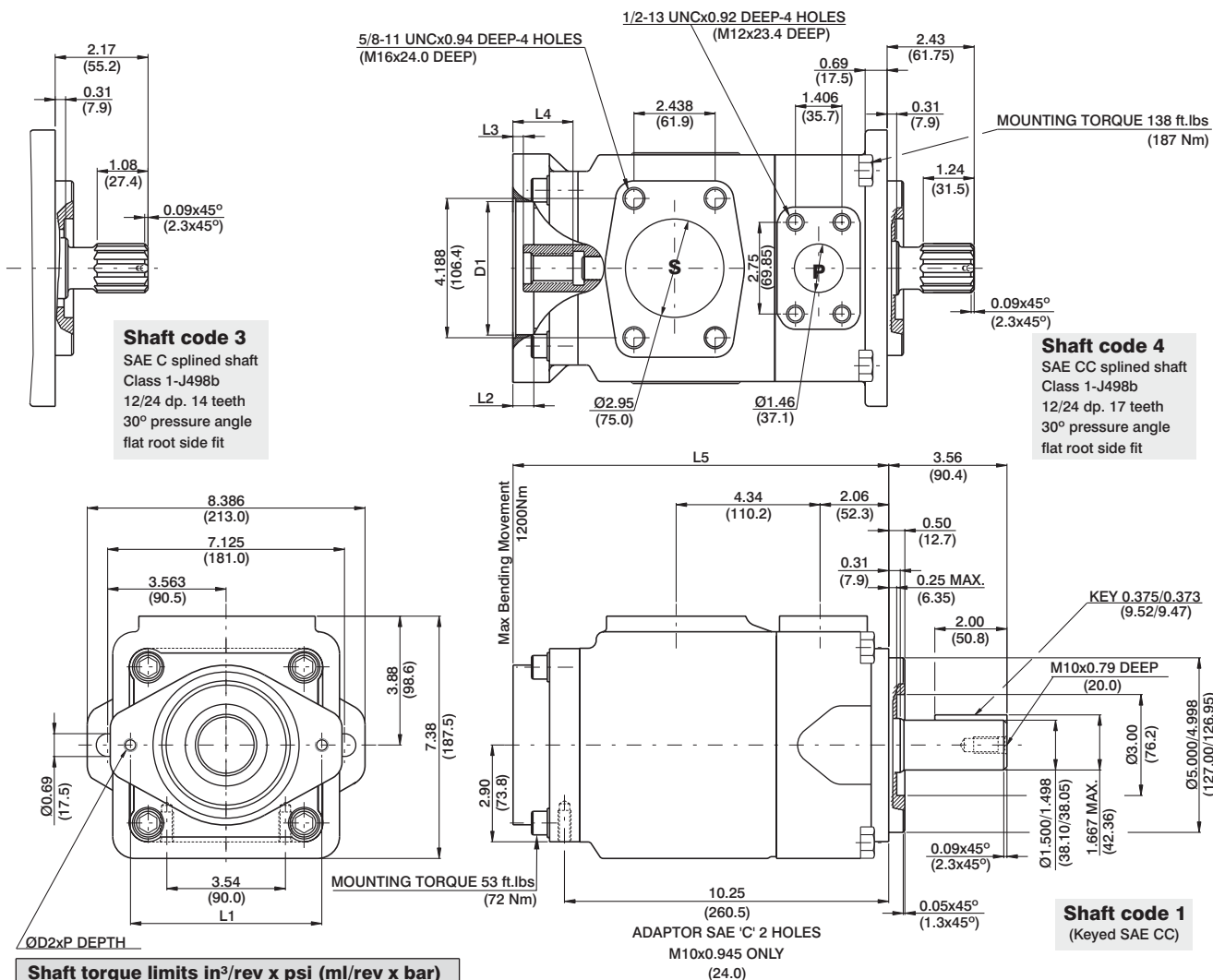

Shaft torque limits in³/rev x psi (ml/rev x bar)

Shaft	V x P max.	Coupling drive	V x P max.
1	71355 (80560)	SAE"A"	9743 (11000)
3	54207 (61200)	SAE"B"	18246 (20600)
4	106474 (120210)	SAE"BB"	28937 (32670)
		SAE"C"	58884 (66480)
		SAE"11teeth"	14039 (15850)

Adaptor	D1	D2	P	L1	L2	L3	L4	L5
SAE "A"	3.25 (82.60)	M10	0.94 (24)	4.19 (106.4)	0.43 (11)	0.31 (7.9)	1.26 (32)	10.71 (272)
SAE "B"	4.00 (101.65)	M12	1.10 (28)	5.75 (146.0)	0.63 (16)	0.31 (7.9)	1.81 (46)	11.26 (286)
SAE "C"	5.00 (127.10)	M16	-	7.12 (181.0)	0.63 (16)	0.31 (7.9)	2.20 (56)	11.65 (296)

Adaptor	SAE "A"			SAE "B"		SAE "C"
Coupling drive	SAE A	SAE (11teeth)	SAE B	SAE B	SAE BB	SAE C
Number of teeth	9	11	13	13	15	14
Pitch	16/32	16/32	16/32	16/32	16/32	12/24
Pressure angle	30°	30°	30°	30°	30°	30°
Major dia.(min)	0.625 (15.875)	0.750 (19.05)	0.875 (22.225)	0.875 (22.225)	1.00 (25.40)	1.250 (31.75)
Minor dia.(min)	0.500 (12.70)	0.630 (16.00)	0.753 (19.134)	0.753 (19.134)	0.877 (22.268)	1.086 (27.585)

OPERATING CHARACTERISTICS - TYPICAL (24 cST)

Pressure port	Series	Volumetric Displacement Vp		Flow q & n = 1500 rpm						Input power p & n = 1500 rpm					
		p = 0 bar (0 psi)		p = 140 bar (2000 psi)		p = 240 bar (3500 psi)		p = 7 bar (100 psi)		p = 140 bar (2000 psi)		p = 240 bar (3500 psi)			
		in ³ /rev	cm ³ /rev	gpm	lpm	gpm	lpm	gpm	lpm	hp	kw	hp	kw	hp	kw
VT6ER	042	8.07	132.3	52.50	198.5	49.87	188.5	47.96	181.3	6.97	5.2	66.25	49.4	110.77	82.6
	045	8.70	142.4	56.51	213.6	53.86	203.6	51.98	196.5	7.24	5.4	70.94	52.9	118.95	88.7
	050	9.67	158.5	62.88	237.7	60.24	227.7	58.36	220.6	7.64	5.7	78.45	58.5	131.82	98.3
	052	10.00	164.8	65.40	247.2	62.75	237.2	60.87	230.1	7.78	5.8	81.53	60.8	136.92	102.1
	057	11.02	180.7	71.71	271.1	69.07	261.1	67.19	254.0	8.18	6.1	89.04	66.4	143.35	106.9
	062	12.00	196.7	78.04	295.0	75.40	285.0	73.52	277.9	8.58	6.4	96.42	71.9	162.67	121.3
	066	13.00	213.3	84.63	319.9	81.98	309.9	80.11	302.8	8.98	6.7	104.20	77.7	175.94	131.2
	072	13.86	227.1	90.11	340.6	87.46	330.6	85.58	323.5	9.25	6.9	110.77	82.6	187.07	139.5
085 ¹⁾	16.40	269.8	107.00	404.7	105.21 ²⁾	397.7 ²⁾	--	--	9.78	7.3	87.56 ²⁾	65.3 ²⁾	--	--	

1) 085 = 2000 RPM max.

2) 085 = 75 bar (1100 psi) cont.

085 = 90 bar (1300 psi) max. int.